



SCISSORS LIFTS DUO CM

made by MAHA



FOR VEHICLES UP TO 5.0 t GROSS WEIGHT

More than 25 years experience, particularly its close cooperation with test organizations involved in vehicle inspection and with reputable vehicle manufacturers regarding wheel alignment, have made MAHA a market leader.

MAHA stands for high-tech vehicle inspections and workshop fitting. As one of the most productive manufacturers, the company supplies workshop fitting that covers the entire range from test benches and vehicle lifts to various inspection devices for cars, utility vehicles, motorbikes and special-purpose vehicles. With the option of linking individual test devices to form universal test lanes, MAHA has become a skilled technical partner all over the world. MAHA products meet the highest quality standards, represent reliability and a long service life and satisfy the most demanding requirements.



Founded by Winfried Rauch in 1969, the company has since become a pioneer in many areas of workshop fitting. As a company that pioneers and inspires, we enjoy exploring new avenues. Our many years of experience and innovative technical developments allow us to lead the market.

MAHA employs over 1200 workers in over 150 countries worldwide and is represented internationally by agencies and its own branch offices. This allows customers the world over to be provided with high-quality testing and lifting equipment. The lean company structures and direct communication channels allow products to be adapted to suit the legislation of each country with great flexibility. With a commitment to providing quality, reliability and value for money.

In addition to hardware, MAHA provides powerful software solutions for linking test systems. This is accompanied by consulting services for the planning and implementation of construction projects and efficient direct check-in. The company's skills thus extend far beyond pure machine engineering.

TECHNOLOGY

Advantages of Synchronisation with the "Linear-Absolute-Travel Measurement"

The measurement system integrated in the lifting cylinders permanently measures the piston stroke. The lift control ensures equal height of runways and wheel-free jack over the entire lifting range.

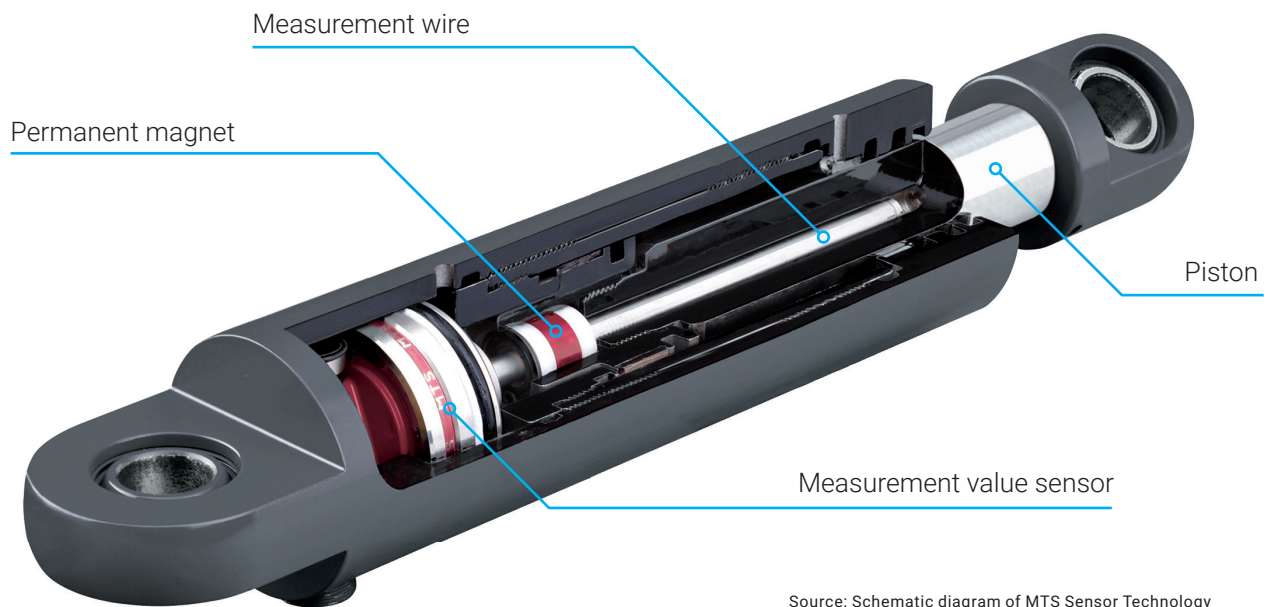

Source: Schematic diagram of MTS Sensor Technology

- Measurement system integrated in cylinder, completely protected against dirt, moisture, temperature fluctuations
- Non-contact measurement system making it free of wear and tear
- The operator is freed from levelling of runways and wheel-free jack
- Lift stops lowering movement automatically at one-sided collision with an obstacle (no diagonal light barrier needed)
- Programmable hold point for automatic stopping at ergonomic working heights, individually adaptable to operator's body height
- No keys or inductive sensors needed to determine relevant lifting heights "Lift lowered/Lift raised/CE Stop height", meaning less cables and components at the lift
- Short raising/lowering time of the optional wheel-free jack (load dependent ca. 10/10 s)
- Two parallelly switched lifting cylinders (no master-slave principle), for less system pressure, ensuring high life-time of hydraulic components

CORROSION PROTECTION

Aggressive winter spreading agents, cleaning agents as well as brake fluid and refrigerants have a corrosive effect on the lift. Structural measures and a highly efficient surface treatment using powder coating technology offer excellent corrosion protection for mechanical components. Pipe profiles and inaccessible areas are additionally provided with a cavity sealing, weld seams with a silicone coat.

- Further optional corrosion protection possibilities (extra charge):
- Zinc spraying and then powder coating
- Hot dip galvanizing (not possible with lifts used for wheel alignment due to thermic deformation)
- Two-coat powder painting
- Granulate coating of runways and compensating plates

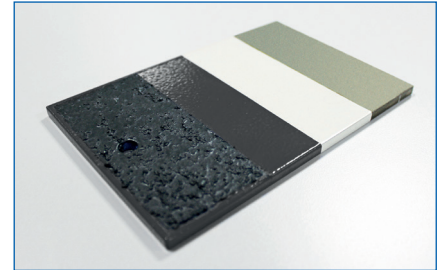
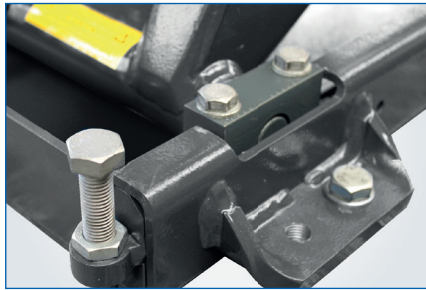
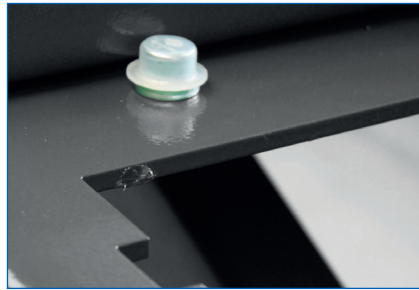

Fig.: Sample sheet with two-coat painting:
- Powder primer (epoxy resin) - 1st coat
- Polyester powder - 2nd coat
- Granulate coating (optional)



All standard components (screws etc.) have a zinc/aluminium coating, hydraulic fittings and steel pipes are zinc/nickel plated.



Numerous metal contact surfaces are separated from one another by synthetic/rubber elements.

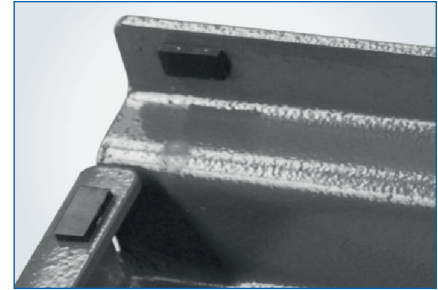

INSTALLATION VARIATIONS

In comparison to four post lifts, scissors lifts are extremely space-saving. There are two possible installation variations: Flush-floor (inground) in a foundation or surface mounted (above-ground).

- Advantages of inground installation:
- Safe and easy drive-on, also for vehicles with low ground clearance
- Low working place length
- Rectangular foundation with optional grating
- Strip foundation can be driven over in crosswise direction; ideal for narrow approach areas, no steps or tripping points
- Optional centre platform (see page 12)
- Generous lifting height of min. 2070 mm allows a usable height of min.** 1850 mm in strip foundation
- The DUO CM 4.2 U is optionally available with a drive-over axle load of 10 t*



Effective height of min. 1850** mm with installation in strip foundation.

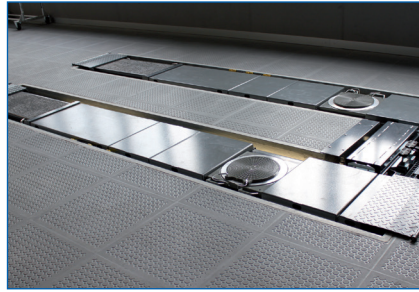

DUO CM in strip foundation (equipped for wheel alignment).

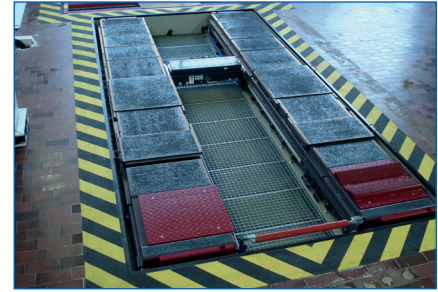

DUO CM in rectangular foundation with (optional) grating, (equipped for vehicle inspection test).

Optional axle lift in conjunction with axle lift floor cover, available for installation in strip foundation:

The floor cover moves synchronously with the axle lift and closes the park position recess. The raised lift floor cover can be loaded with up to 200 kg. The axle lift is monitored by proximity switch, lowering of main lift is possible only when the axle lift is in park position.

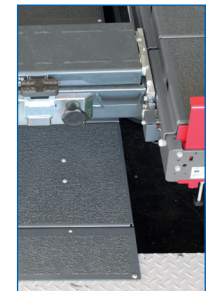

Optional centre platform:

Large casing made of stainless steel, mounted between the scissors in rectangular foundation, integrates the complete hydraulic and electric systems of the lift.



Advantages of surface mounted installation:

High strength materials and an innovative lifting technology enable a flat design for easy access to the lift.

The DUO CM 4.2 A has the option "Tilting of the Runways", which is offered in two variations (hydraulic or manual). Thanks to the front-sided lifting of the runway, the "bend" between the drive-on ramp and the runway is minimized. Stepped drive-on ramps made of aluminium are optionally available as an additional drive-on assistance. Due to their low weight these can be attached to the steel ramps manually when needed.



DUO CM AS TEST LANE LIFT

TECHNOLOGY AND PRODUCT ADVANTAGES



High-powered drive unit – designed for extremely large number of lifting cycles.



The pneumatically activated latch serves as a safety against downward movement with hydraulic leakage.



Cables and hydraulic hoses placed within the scissors tubes and in energy guidance chains. Optimum protection against damage!

The usable runway length is increased by the optional roll-off protection. Retraction at a lowered position is low noise and without floor contact.

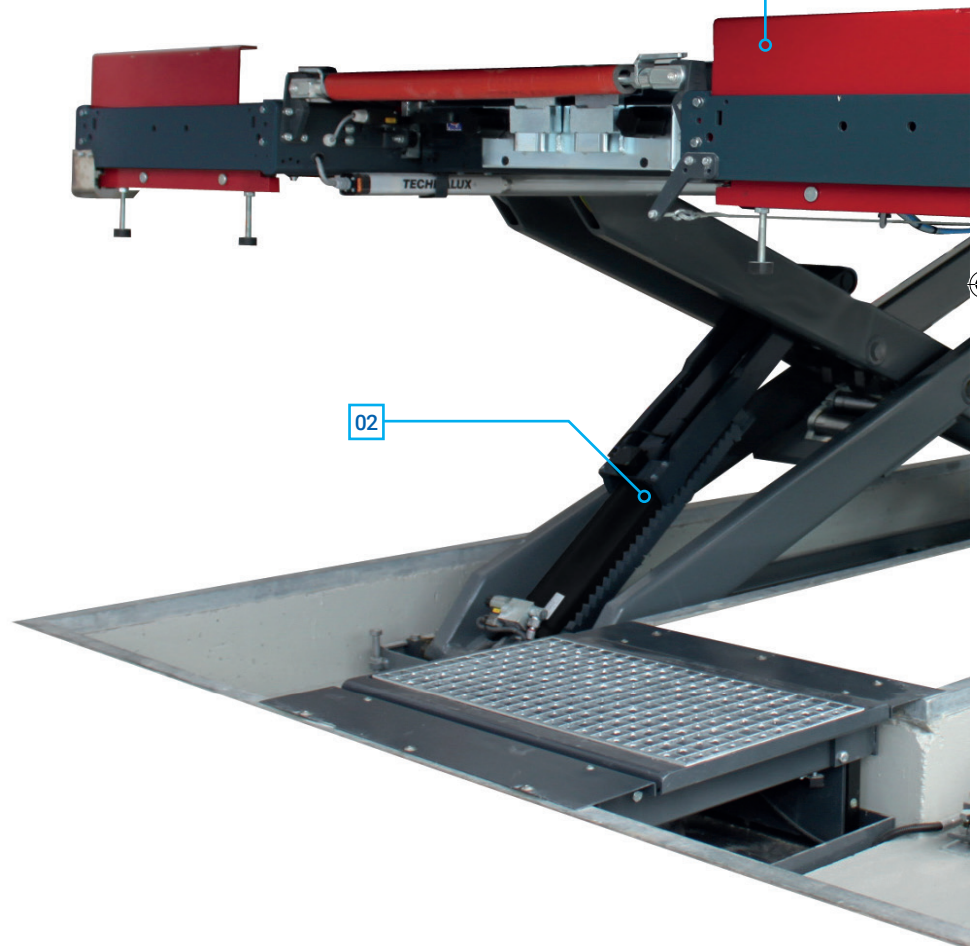

With the generous lifting height of ca. 2100 mm ideal for installation in a strip foundation or in conjunction with a centre platform.



Axle play detector hydraulic:
High forces and defined travel
of the test plates possible, high
test efficiency.

The CE Stop (acoustic warning signal) secures all pinch and crush spots. Longitudinal infra-red light barriers are optionally available, offering extra crush protection for working areas in which persons are present (e.g. vehicle test stations).



2 compressed air quick couplings (in a runway) as standard delivery.

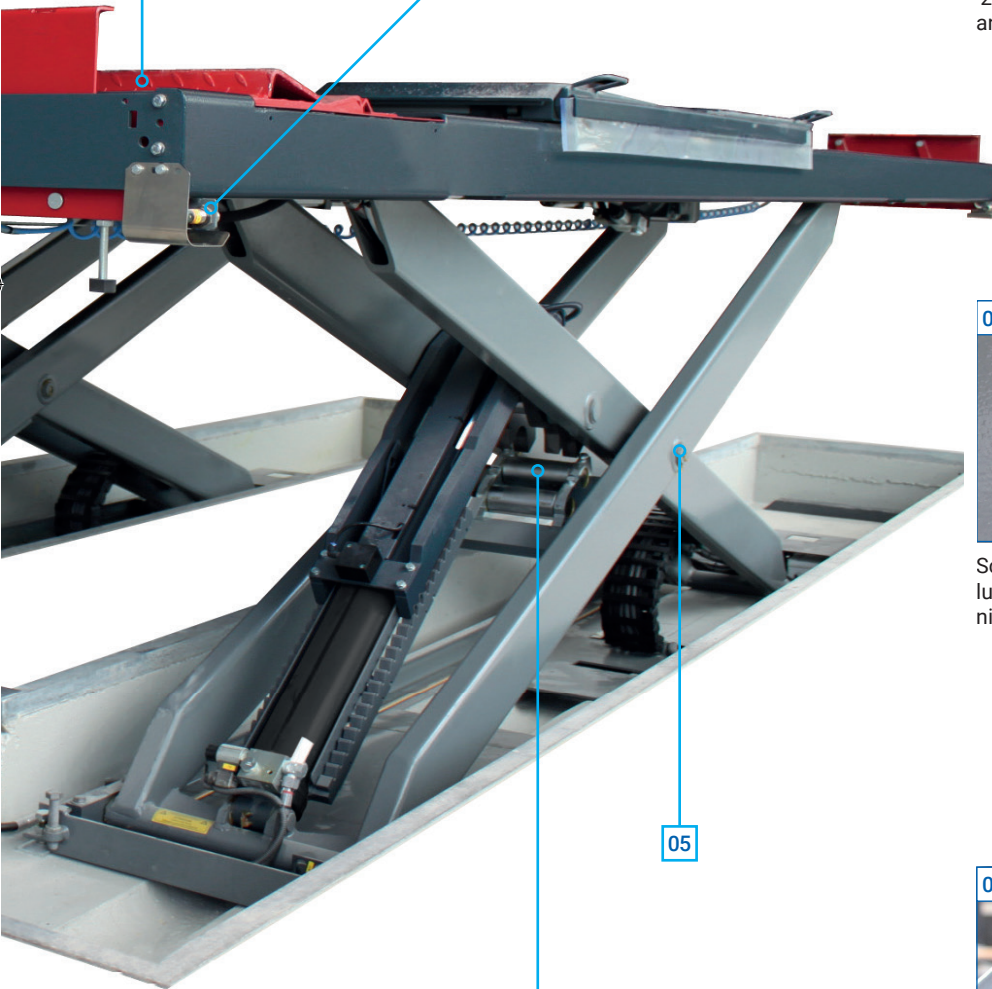

Scissors main bearing with Teflon bearing bushing and lubrication nipple, long service life and emergency running qualities.



The cylinder raising support with step lever and rollers conducts a pure rolling movement. No sliding movement between the moving parts, meaning it is low noise, wear resistant and nearly maintenance-free.

06

05

06



DUO CM FOR WHEEL ALIGNMENT

HIGH FLEXURAL AND TORSIONAL RIGIDITY.
IDEALLY SUITED FOR WHEEL ALIGNMENT.



Technology and Product Advantages

The DUO CM 4.2 can be adjusted in all degrees of freedom. Vehicle manufacturers have issued approvals for this lift for use in wheel alignment.

The generous runway length of max. 4.8 (DUO CM 4.2) and 5.2 m (DUO CM 5.0) makes it ideal for 3D wheel alignment.



Option "Lowering Device": LCD display at operation desk for display of the current height level.

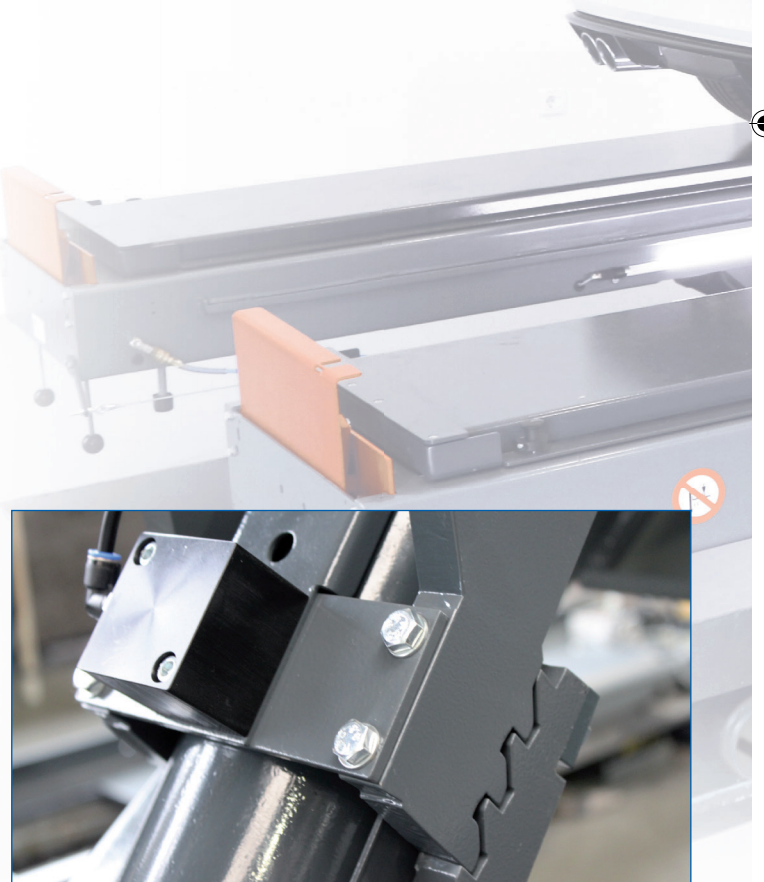

The tothing of the mechanical locks for wheel alignment lifts is machined by milling (option "Lowering Device"). This ensures high measuring accuracy at different working heights.

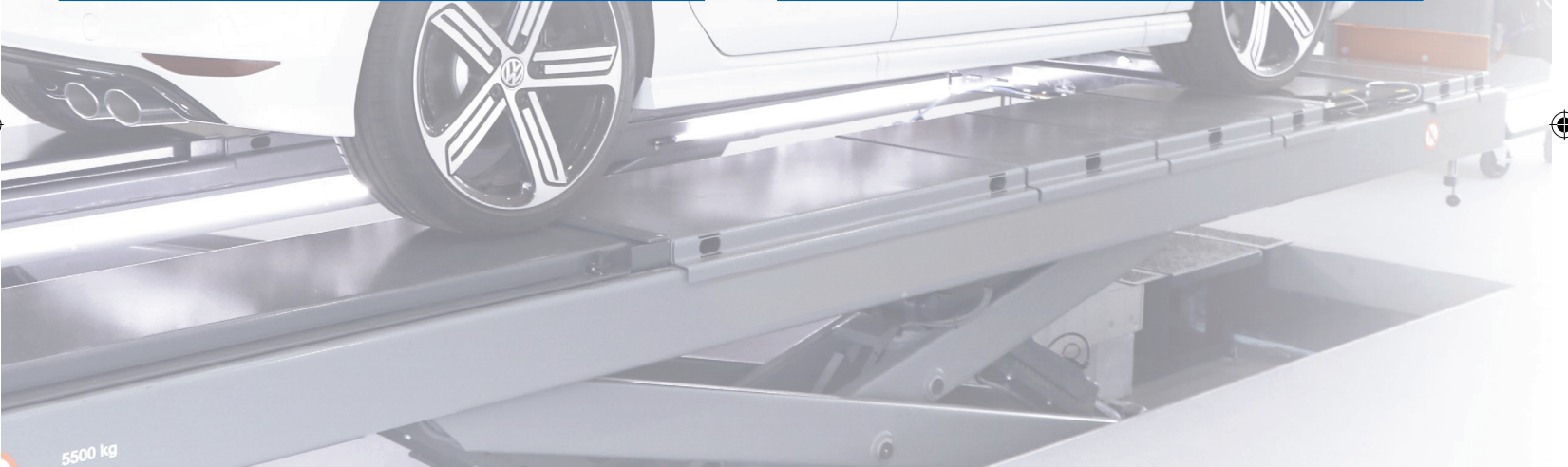

Option "Lowering Device": After welding, the runways for wheel alignment lifts are straightened exactly flat in the area of the turntables and sliding plates.

Adjustable bearing enables independent alignment of runway to scissors.

OPTIONS

Automatic Roll-off Protection:

- Larger effective runway length
- Low noise operation
- No contact to floor

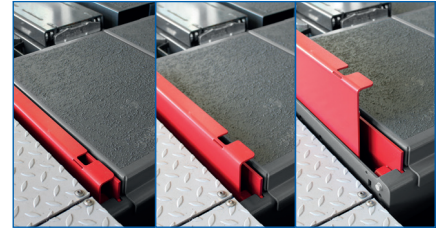

Incline Position (DUO CM 4.2 A):

- Hydraulic or mechanic
- For easier drive-on and drive-off (with surface mounted lift version)



Axle Lift:

- With the axle lift AL II 2.0 / 2.6 (PH) the long extension length for wheel alignment makes it possible to lift the axle at the suspension without compressing the wheels.

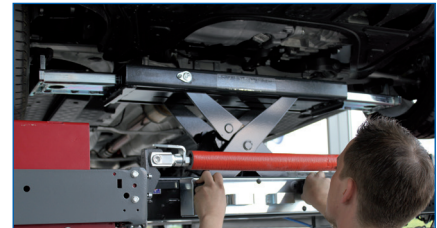

Pneumatic Floor Cover:

- In conjunction with strip foundation or centre platform and axle lift
- Raises and lowers automatically with the lift
- Automatically covers the axle lift's park position

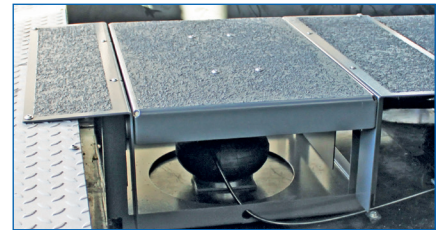

OPTIONS FOR WHEEL ALIGNMENT

Hand Pump for Manual Lowering:

- Stored in operation desk
- Recommended for versions used with wheel alignment



Sliding Plates:

- Possible rotation movement +/- 5°
- Lateral movement from +/- 50 mm

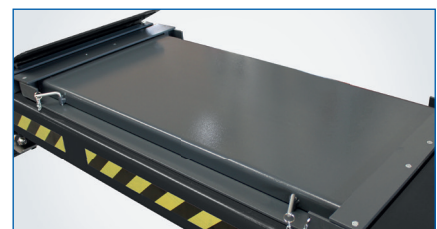



Aluminium Step Ramp:

- For vehicles with low ground clearance
- Low net weight, attachable to the steel ramp when needed
- Total ramp length: 2.5 m



Wheel-Free Jack:

- The entire vehicle is raised wheel-free
- Large extension lengths
- Granulate coating (standard) secures vehicle against slipping off
- Extensions can be pulled out in fully lowered position



Longitudinal Light Barrier for Crush Protection on Runway Outside:

- Expanded crush protection
- Lift stops automatically when a body part enters a danger zone



Illumination:

- Two-fold and four-fold illumination on the runway (optional: LED). The LED lights are swivel-mounted in their holders. In this way, the light output can be focused precisely on the area to be illuminated, and glare can be easily avoided.

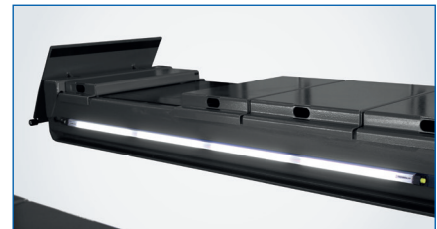

Compensation and Support Plates for Turning Plates:

- The turntables are secured against slippage in longitudinal direction. When not in use, the turntables can be removed from the lift and the hole closed with additional compensating plates (optional).



Double Latch for Wheel Alignment:

- Additional stability within the scissors arm
- Not possible in conjunction with wheel-free jack



OPTIONS FOR VEHICLE INSPECTION

Centre Platform:

- Large casing made of stainless steel, mounted between the scissors in rectangular foundation
- Hydraulic and electric systems completely integrated
- Compact operating box with optically appealing stainless steel panel, no large operating desk
- Operating unit suitable for assembly at the wall or installation on pedestal (optional)
- Short and easily accessible hydraulic hoses within the centre platform. Time and cost saving when exchanging old hydraulic hoses.
- Simple, cost effective rectangular foundation
- Sufficient effective lifting height 1.85 m of DUO CM lift in conjunction with centre platform
- Granulate coating for anti-slip surface
- Wheel load capacity 1.5 t for manoeuvring in critical drive-on areas
- High corrosion protection with standard two-coat powder painting
- Manual lowering of lift can be performed from outside danger zone

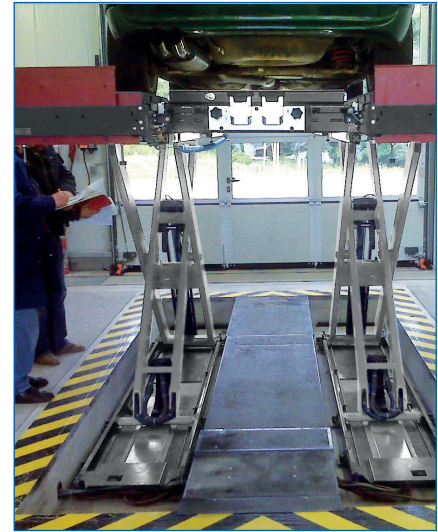
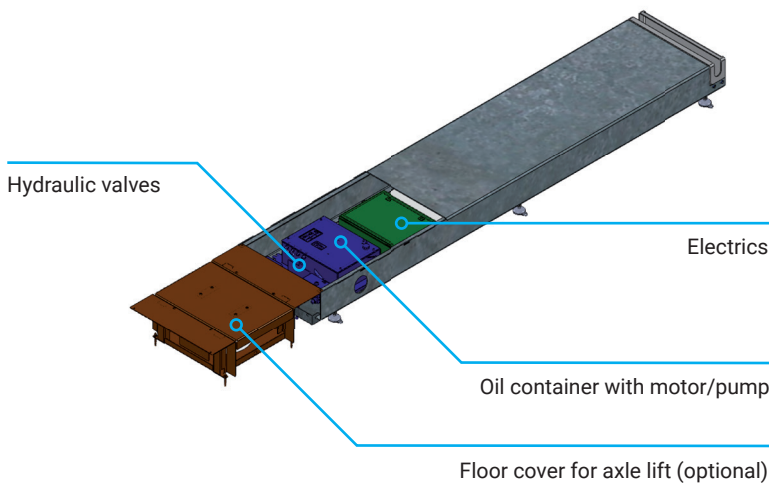

Centre platform facilitates an effective lifting height of 1850 mm.



Operating unit with optically appealing sheet steel cover for wall attachment or free-standing pedestal.

Radio Handlamp for Axle Play Detector:

- Small size for excellent handling L x W x H = 190 x 60 x 36 mm, low weight and ergonomic form as well as anti-slip, rubber surface
- High breakage resistance due to fiberglass housing and mechanical shock protection
- LED lighting with intense lighting power and low electrical consumption
- Battery 3.6 VDC / 2100 mAh with high capacity (ca. 7 h constant light with fully charged battery possible, recharging time ca. 6 h with completely discharged battery)
- Various fixing and storage possibilities via loop, clip and magnet
- Rugged, mechanical transmission key for moving the axle play detector
- Rugged foil keypad as function keys
- Includes mountable battery charger with internal connector. Battery is recharged each time the handlamp is plugged in





Axle Play Detector:

- Driven via hydraulic power unit of lift
- High test forces and defined travel paths of the test plates
- Quick detection of defects and wear on steering parts, wheel bearings, springs and suspension



Front axle



PMS 3/X (L)

Movement of right-hand plate (flat):
transverse movement
Movement of left-hand plate (prism):
shear movement

Rear axle



or



PMS3/R

Movement: individually transverse and longitudinal. on the other side synchronously transverse and longitudinal

PMS 3/D

Movement: individually diagonal

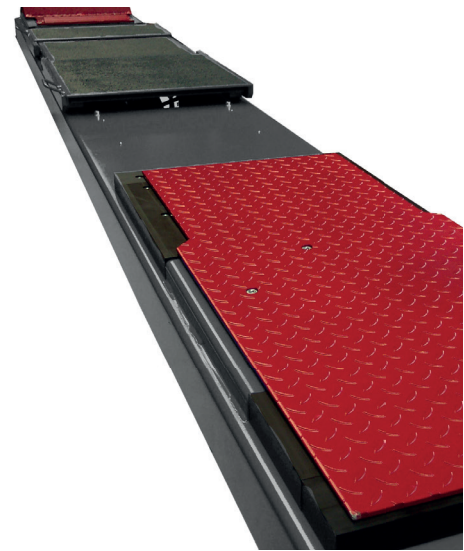

PMS 3/XL:

- In conjunction with the MAHA headlight tester positioned in front of the lift
- Rear prism half raises and lowers automatically and synchronously with the lift in fully lowered position
- All four wheel contact surfaces of the vehicle are at the same level

Lift lowered:



Rear prism half is automatically lowered, all four wheel contact surfaces are level.

Lift raised:



Rear prism half is automatically extended for axle test.

Due to the optimum position of the wheel-free jack in relation to the axle play detector, as well as the asymmetric wheel-free jack extension, vehicles with both long and short wheelbases can be lifted directly with the wheel-free jack. Shifting the vehicle on the runways is not necessary (DUO CM 4.2).



OPTIONS WHEEL-FREE JACK

Using the optional wheel-free jack, the entire vehicle can be lifted wheel-free quickly and safely.

- Support plates have the identical width as the lift runways
- Extensions with extremely large adjustment range up to a max. of 2100 mm – lifting of small vans also possible



- The support plates and extensions come standard with granulate coating. This creates high anti-slip protection when climbing out of the vehicle.



- High anti-slip properties between support blocks and plates when lifting the vehicle due to granulate coating.



In conjunction with wheel alignment accessories/compensating plates:

The support plates can also be extended in totally retracted position and need not be pushed in for complete lowering of the wheel-free jack.

- Problem-free lifting of vehicles with low ground clearance
- Higher operating comfort and time savings, especially with high vehicle throughput



TECHNICAL DATA

	DUO CM 4.2	DUO CM 5.0
Load capacity CE	4,2 t	5,0 t
Overall dimensions L x B (surface mounted)	5900 x 2075 mm	6700 x 2210 mm
Runway length (standard) LF	4400 mm	5200 mm
Runway length, optional	4800 mm	-
Runway width BF	617 mm	630 mm
Drive-on height (surface mounted) without accessories with accessories / compensating plates	240 mm 290 mm	290 mm 340 mm
Lifting height H max. (surface mounted)	2075 mm	2140 mm
Raising/Lowering time, load dependent ca.	45 s / 45 s	50 s / 40 s
Short raising/lowering time, load dependent ca. (optional)	20 s / 20 s oder 12 s / 12 s	15 s / 18 s oder 30 s / 30 s
Hydraulic unit	2,5 kW	2,5 kW
Hydraulic oil quantity	40 l	40 l
Power supply	3 x 400 V / 50 Hz	3 x 400 V / 50 Hz
Shipping weight	2700 kg	3200 kg

WHEEL-FREE JACK

Load capacity	3,5 t	3,5 t
Extension length LR	1400 – 2100 mm	1400 - 2100 mm
Lifting height HR without accessories	60 – 450 mm	60 – 450 mm
Raising/Lowering time, load dependent ca.	10 s / 10 s	10 s / 10 s

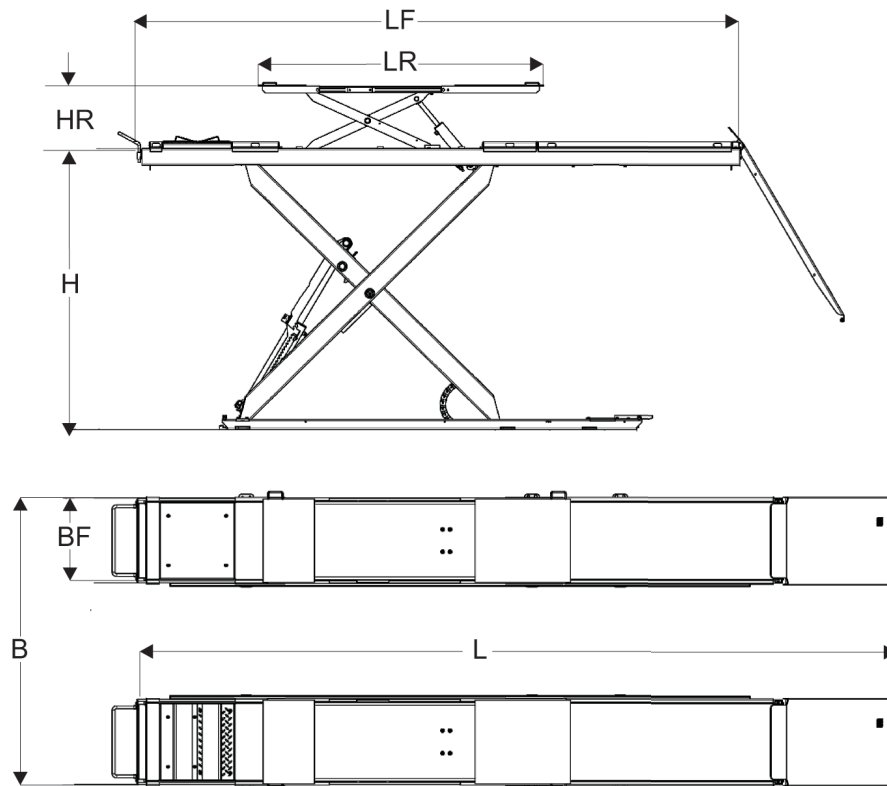

Diagram: DUO CM 4.2 A with PMS 3/X, wheel-free jack and compensating plates

ACCESSORIES (SELECTION)

	DUO CM 4.2	DUO CM 5.0
Installation surface	+	+
Installation inground (also strip foundation)	+	+
Extended runway 4.8 m	0	-
Short raising/lowering time	0	0
Roll-off protection, automatic	0	0
Wheel-free jack 3.5 t	0	0
Illumination 2-/4 fold	0	(only 4-fold) 0
Illumination LED 2/4 fold	0	0
Shockproof socket	0	0
Lowering device and equipping for wheel alignment	0	0
Recommendation of vehicle manufacturers for wheel alignment	+	+
Grating with inground installation	0	-
Centre platform	0	-
Inclination with surface mounting	0	-
Axle play detector, hydraulic, for front axle	0	0
Axle play detector, hydraulic, for rear axle	0	-
Axle lift 2.0/2.6 t	0	0
Floor compensation for axle lift in strip foundation	0	0
10 t load drive-over*	0	-
Pneumatic quick-action coupling at runways	S	S

- + Suitable
- 0 Optional
- Not available
- S Standard

* Vehicle gross weight max. 10 t or axle load max. 10 t with wheelbase min 3.0 m

BR080001-en 13 - Subject to technical changes without notice. The illustrations include options not part of the standard scope of delivery.

MAHA Maschinenbau Haldenwang GmbH & Co. KG
 Hoyen 20
 87490 Haldenwang
 Germany

maha.de