



MOBILE COLUMN LIFT

» ALWAYS CONNECTED «

made by MAHA
made
in
Germany



C_RGA: WIRELESS & SAFE

» ALWAYS CONNECTED «

ELECTROMECHANICAL DRIVE RELIABLE AND COMPLETELY OIL-FREE

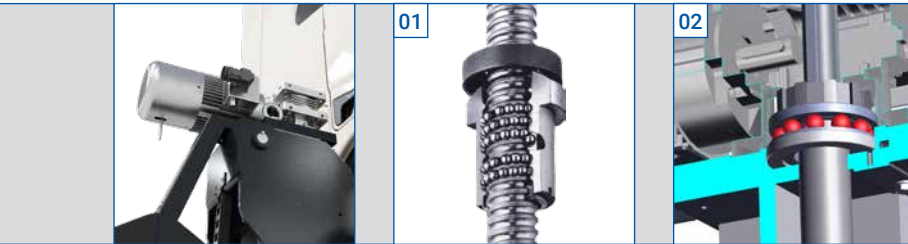

Very smooth running and precision height positioning without overrun thanks to a high quality, maintenance-free worm gear motor.

High efficiency and low wear due to smooth-running and low-maintenance recirculating ball nut with over 100 balls.

Ball screw mounted suspended in maintenance-free roller bearing.

SOPHISTICATED TECHNOLOGY FOR HIGH MECHANICAL SAFETY

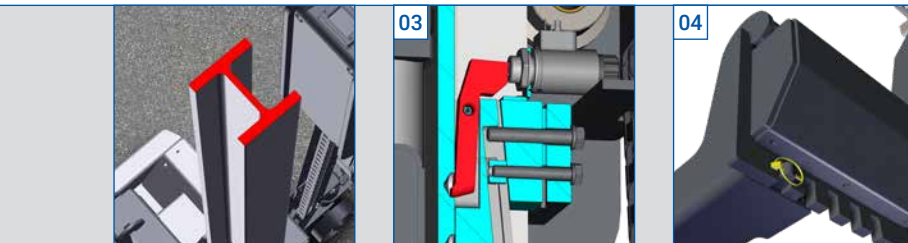

Excellent mechanical rigidity of columns thanks to a tried and trusted H-profile.

Safety in the event of load nut breakage thanks to mechanically independent locking device.

Adjustable lifting carriage with positive-locking of forks and securing by means of cotter pin.

PRACTICAL AND CONVENIENT HANDLING



Hydraulic dolly for easy manoeuvring, even over higher ground thresholds.

Minimal turning radius owing to optimised design.

Highly streamline column design offers a good overview for manual manoeuvring.



02 Automatic shutdown in case of overload.

07 Workshop-robust and spray-proof plastic control panel on every column.

Large silicone control buttons – mechanical and workshop-oriented.

Excellent protection for cables through guidance within a high quality energy chain.

01

03

05

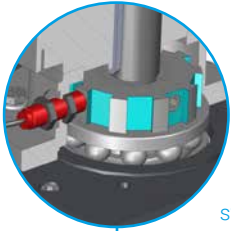

Height measurement via touchless, non-wearing inductive proximity switches.



Simple and secure pairing of columns via NFC tag (patent pending).

SECURE DATA COMMUNICATIONS WIRELESS AND INTERFERENCE-FREE



Modern LoRa® radio modulation: unimpeded and interference-free.

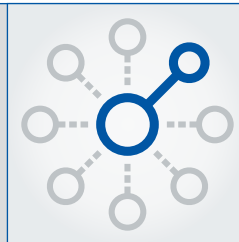

Automatic 'Channel Hopping' selection of a suitable free radio channel by the system.



Intelligent control technology to facilitate an unlimited number of column groups at one site.



Unique energy supply via lithium-ion battery integrated into the operating unit – very long lifespan and fast charging time.

INTUITIVE OPERATION LED-GUIDED



'All/Single/Group' operating modes securely selected via individual buttons.



LED display of operating states and error codes.



Depending on the load, high lifting and lowering speeds can be selected via separate, additional button.

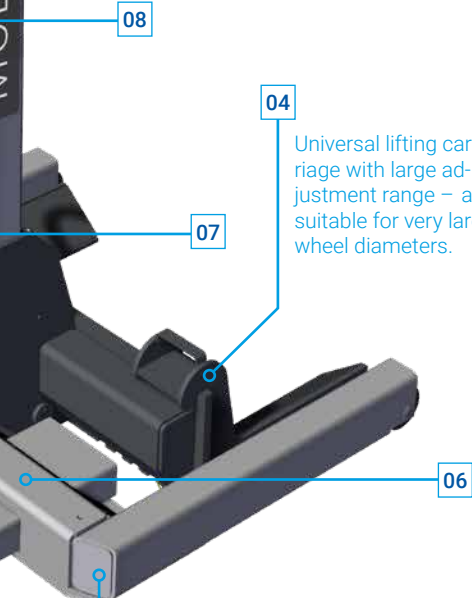

04 Universal lifting carriage with large adjustment range – also suitable for very large wheel diameters.

07

06

Low chassis and no interfering contours due to missing batteries. This enables positioning even on vehicles with low ground clearance (e.g. buses).

ADDITIONAL PRODUCT ADVANTAGES



05 Chassis with integrated forklift pockets for easy movement of columns over longer distances on site.



06 Optional power supply via four cycle-proof AGM batteries, protected with sturdy covers.



07 Two antennas (top and bottom) ensure a reliable radio connection, even for vehicles with large cubic bodies.

DAISY CHAIN

CABLE CONNECTION AS BACKUP

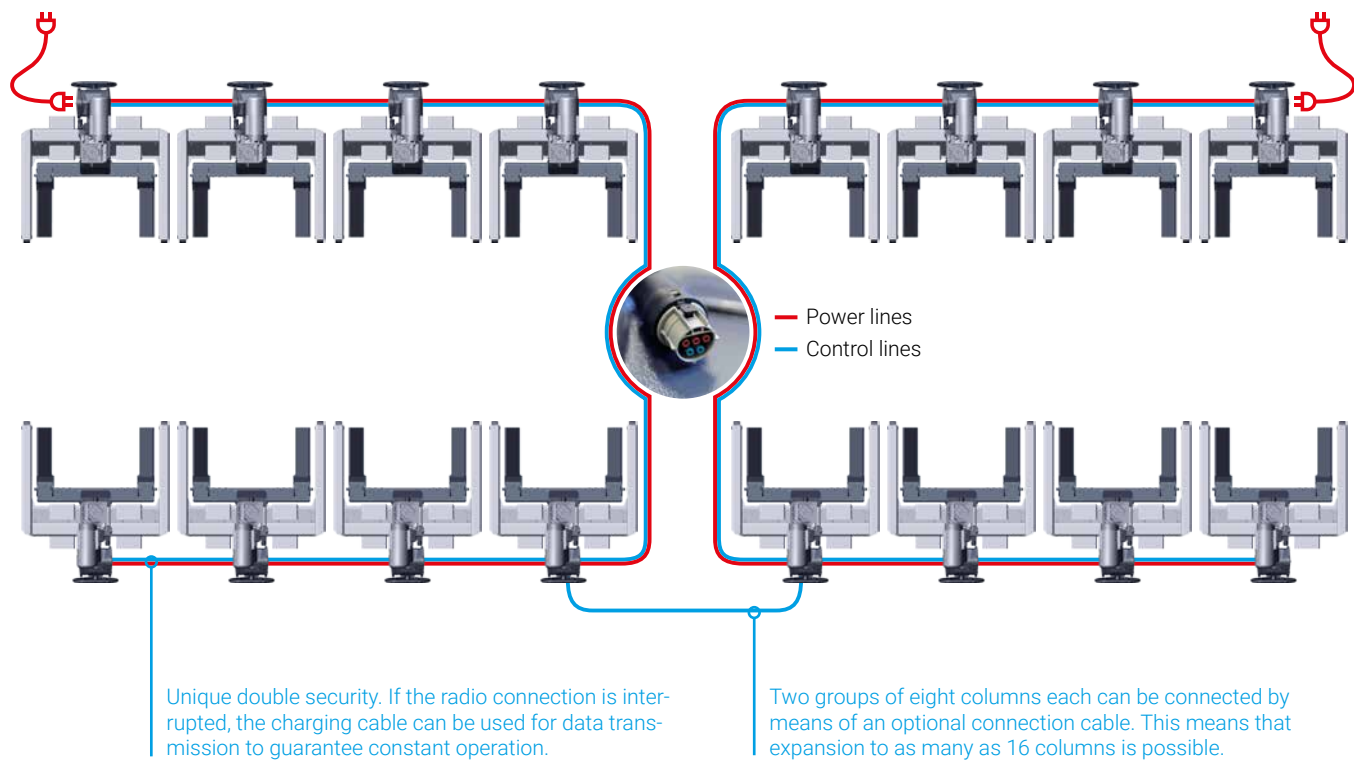

OPTIONS (SELECTION)

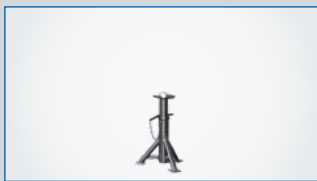

Stand AB 6-07 / 7,500 kg
Adjustment range 470–795 mm



Stand AB 6-12 / 7,500 kg
Adjustment range 875–1,395 mm



Stand AB 6-20 / 7,500 kg
Adjustment range 1,200–1,965 mm



Single column expandable

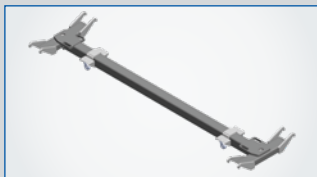

Cross-beam TR8/10 / 8,000/
10,000 kg for wheel-free lifting



Cross-beam for mounting
semi-trailers with 2" king pins